

Keysight Technologies

HMMC-3008 DC-16 GHz

GaAs HBT MMIC Divide-by-8 Prescaler

1GC1-8003

Data Sheet

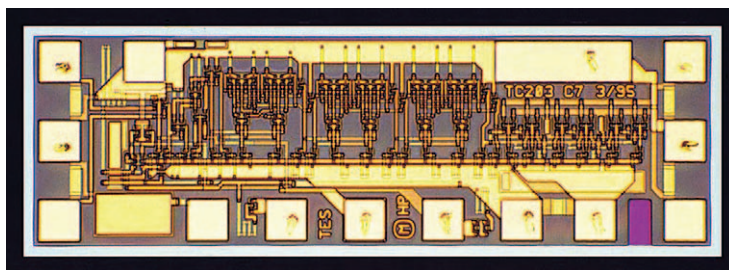

Features

- Wide Frequency Range:
0.2 to 16 GHz
- High Input Power Sensitivity:
On-chip pre- and post-amps
-20 to +10 dBm (1-10 GHz)
-15 to +10 dBm (10-12 GHz)
-10 to +5 dBm (12-15 GHz)
- Dual-mode P_{out} : (chip form)
+6.0 dBm (0.99 V_{p-p}) @ 80 mA
0 dBm (0.5 V_{p-p}) @ 60 mA
- Low Phase Noise:
-153 dBc/Hz @ 100 kHz Offset
- (+) or (-) Single Supply Bias operation
- Wide bias supply range: 4.5 to 6.5 volt operating range
- Differential I/O with on-chip 50 Ω matching

Description

The Keysight Technologies, Inc. HMMC-3008 GaAs HBT MMIC Prescaler offers dc to 16 GHz frequency translation for use in communications and EW systems incorporating high-frequency PLL oscillator circuits and signal-path down conversion applications. The prescaler provides a large input power sensitivity window and low phase noise. In addition to the features listed above the device offers an input disable contact pad to eliminate any self-oscillation condition.

Absolute Maximum Ratings¹

(@ $T_A = 25^\circ\text{C}$, unless otherwise indicated)

Symbol	Parameters/conditions	Min	Max	Units
V_{CC}	Bias supply voltage		+7	volts
V_{EE}	Bias supply voltage	-7		volts
$V_{CC}-V_{EE}$	Bias supply delta	0	+7	volts
$V_{Disable}$	Pre-amp disable voltage	V_{EE}	V_{CC}	volts
V_{Logic}	Logic threshold voltage	$V_{CC} - 1.5$	$V_{CC} - 0.2$	volts
$P_{in(CW)}$	CW RF input power		+10	dBm
V_{RFIn}	DC input voltage (@ RF_{in} or \overline{RF}_{in} ports)		$V_{CC} \pm 0.5$	volts
T_{BS}^2	Backside Ambient Temperature	-40	+85	$^\circ\text{C}$
T_{st}	Storage Temperature	-65	+165	$^\circ\text{C}$
T_{max}	Max. Assembly Temperature (60 s max.)		310	$^\circ\text{C}$

1. Operation in excess of any parameter limit (except T_{BS}) may cause permanent damage to the device.
2. MTTF > 1×10^6 hours @ $T_{BS} \leq 85^\circ\text{C}$. Operation in excess of maximum operating temperature (T_{BS}) will degrade MTTF.

DC Specifications/Physical Properties¹

($T_A = 25^\circ\text{C}$, $V_{CC} - V_{EE} = 5.0$ volts, unless otherwise listed)

Symbol	Parameters/conditions	Min.	Typ.	Max	Units
$V_{CC} - V_{EE}$	Operating bias supply difference ¹	4.5	5.0	6.5	Volts
$ I_{CC} $ or $ I_{EE} $	Bias supply current (High output power configuration ² : $V_{PwrSel}=V_{EE}$)	73	86	99	mA
	Bias supply current (Low output power configuration: $V_{PwrSel}=\text{open}$)	56	66	76	mA
$V_{RFIn(q)}$, $V_{RFout(q)}$	Quiescent dc voltage appearing at all RF ports		V_{CC}		Volts
V_{Logic}	Nominal ECL Logic Level (V_{Logic} contact self-bias voltage, generated on-chip)	$V_{CC} - 1.45$	$V_{CC} - 1.35$	$V_{CC} - 1.25$	Volts

1. Prescaler will operate over full specified supply voltage range, V_{CC} or V_{EE} not to exceed limits specified in Absolute Maximum Ratings section.
2. High output power configuration: $P_{out} = +6.0$ dBm ($V_{out} = 0.99 V_{p-p}$). Low output power configuration: $P_{out} = 0$ dBm ($V_{out} = 0.5 V_{p-p}$).

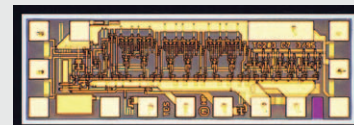

Chip size:
1330 x 440 μm (52.4 x 17.3 mils)
Chip size tolerance:
 $\pm 10 \mu\text{m}$ (± 0.4 mils)
Chip thickness:
 $127 \pm 15 \mu\text{m}$ (5 ± 0.6 mils)
Pad dimensions:
 $70 \times 70 \mu\text{m}$ (2.8 x 2.8 mils)

RF Specifications

($T_A = 25\text{ }^\circ\text{C}$, $Z_0 = 50\text{ }\Omega$, $V_{CC} - V_{EE} = 5.0\text{ volts}$)

Symbol	Parameters/conditions	Min.	Typ.	Max.	Units
$f_{in(max)}$	Maximum input frequency of operation	16	18		GHz
$f_{in(min)}$	Minimum input frequency of operation ¹ ($P_{in} = -10\text{ dBm}$)		0.2	0.5	GHz
$f_{Self-Osc.}$	Output Self-Oscillation Frequency ²		3.4		GHz
	@ dc (Square-wave input)	-15	> -25	+10	dBm
	@ $f_{in} = 500\text{ MHz}$ (Sine-wave input)	-15	> 20	+10	dBm
P_{in}	$f_{in} = 1\text{ to }10\text{ GHz}$	-15	> -25	+10	dBm
	$f_{in} = 10\text{ to }12\text{ GHz}$	-10	> -15	+10	dBm
	$f_{in} = 12\text{ to }15\text{ GHz}$	-4	> -10	+4	dBm
RL	Small-Signal Input/Output Return Loss (@ $f_{in} < 12\text{ GHz}$)		15		dB
S_{12}	Small-Signal Reverse Isolation (@ $f_{in} < 12\text{ GHz}$)		30		dB
ϕ_N	SSB Phase Noise (@ $P_{in} = 0\text{ dBm}$, 100 kHz offset from a $f_{out} = 1.2\text{ GHz}$ carrier)		-153		dBc/Hz
Jitter	Input signal time variation @ zero-crossing ($f_{in} = 10\text{ GHz}$, $P_{in} = -10\text{ dBm}$)		1		ps
T_r or T_f	Output transition time (10% to 90% rise/fall time)		70		ps
High Output Power Operating Mode³					
P_{out}	@ $f_{out} < 1\text{ GHz}$	4.0	6.0		dBm
	@ $f_{out} = 1.25\text{ GHz}$	4.0	6.0		dBm
	@ $f_{out} = 1.5\text{ GHz}$	3.7	5.7		dBm
$ V_{out(p-p)} $	@ $f_{out} < 1\text{ GHz}$	0.79	0.99		Volts
	@ $f_{out} = 1.25\text{ GHz}$	0.79	0.99		Volts
	@ $f_{out} = 1.5\text{ GHz}$	0.76	0.96		Volts
$P_{Spitback}$	f_{out} power level appearing at RF_{in} or \overline{RF}_{in} (@ $f_{in} = 12\text{ GHz}$, unused RF_{out} or \overline{RF}_{out} unterminated)		-55		dBm
	f_{out} power level appearing at RF_{in} or \overline{RF}_{in} (@ $f_{in} = 12\text{ GHz}$, both RF_{out} and \overline{RF}_{out} terminated)		-75		dBm
$P_{feedthru}$	Power level of f_{in} appearing at RF_{out} or \overline{RF}_{out} (@ $f_{in} = 12\text{ GHz}$, $P_{in} = 0\text{ dBm}$, referred to $P_{in}(f_{in})$)		-30		dBc
H_2	Second harmonic distortion output level (@ $f_{out} = 3.0\text{ GHz}$, referred to $P_{out}(f_{out})$)		-30		dBc
Low Output Power Operating Mode⁴					
P_{out}	@ $f_{out} < 1\text{ GHz}$	-2	0		dBm
	@ $f_{out} = 1.25\text{ GHz}$	-2	0		dBm
	@ $f_{out} = 1.5\text{ GHz}$	-2.3	-0.3		dBm
$ V_{out(p-p)} $	@ $f_{out} < 1\text{ GHz}$	0.39	0.5		Volts
	@ $f_{out} = 1.25\text{ GHz}$	0.39	0.5		Volts
	@ $f_{out} = 1.5\text{ GHz}$	0.38	0.48		Volts
$P_{Spitback}$	f_{out} power level appearing at RF_{in} or \overline{RF}_{in} (@ $f_{in} = 12\text{ GHz}$, unused RF_{out} or \overline{RF}_{out} unterminated)		-65		dBm
	f_{out} power level appearing at RF_{in} or \overline{RF}_{in} (@ $f_{in} = 12\text{ GHz}$, both RF_{out} and \overline{RF}_{out} terminated)		-85		dBm
$P_{feedthru}$	Power level of f_{in} appearing at RF_{out} or \overline{RF}_{out} (@ $f_{in} = 12\text{ GHz}$, $P_{in} = 0\text{ dBm}$, referred to $P_{in}(f_{in})$)		-30		dBc
H_2	Second harmonic distortion output level (@ $f_{out} = 1.5\text{ GHz}$, referred to $P_{out}(f_{out})$)		-35		dBc

1. For sine-wave input signal. Prescaler will operate down to D.C. for square-wave input signal. Minimum divide frequency limited by input slew-rate.

2. Prescaler may exhibit this output signal under bias in the absence of an RF input signal. This condition may be eliminated by use of the Pre-amp Disable ($V_{Disable}$) feature, or the Differential Input de-biasing technique.

3. $V_{PwrSel} = V_{EE}$

4. $V_{PwrSel} = \text{Open circuit}$

Applications

The HMMC-3008 is designed for use in high frequency communications, microwave instrumentation, and EW radar systems where low phase-noise PLL control circuitry or broadband frequency translation is required.

Operation

The device is designed to operate when driven with either a single-ended or differential sinusoidal input signal over a 200 MHz to 16 GHz bandwidth. Below 200 MHz the prescaler input is “slew-rate” limited, requiring fast rising and falling edge speeds to properly divide. The device will operate at frequencies down to dc when driven with a square-wave.

The device may be biased from either a single positive or single negative supply bias. The backside of the device is not dc connected to any dc bias point on the device.

For positive supply operation V_{CC} is nominally biased at any voltage in the +4.5 to +6.5 volt range with V_{EE} (or $V_{EE} \& V_{PwrSel}$) grounded. For negative bias operation V_{CC} is typically grounded and a negative voltage between -4.5 to -6.5 volts is applied to V_{EE} (or $V_{EE} \& V_{PwrSel}$).

Several features are designed into this prescaler:

1. Dual-output power feature

Bonding both V_{EE} and V_{PwrSel} pads to either ground (positive bias mode) or the negative supply (negative bias mode), will deliver ~ 0 dBm [$0.5 V_{p-p}$] at the RF output port while drawing ~ 40 mA supply current. Eliminating the V_{PwrSel} connection results in reduced output -6.0 dBm [$0.25 V_{p-p}$] but at a reduced current draw of ~ 30 mA resulting in less overall power dissipation.

(NOTE: V_{EE} must ALWAYS be bonded and V_{PwrSel} must NEVER be biased to any potential other than V_{EE} or open-circuited.)

2. V_{Logic} ECL contact pad

Under normal conditions no connection or external bias is required to this pad and it is self-biased to the on-chip ECL logic threshold voltage ($V_{CC} - 1.35$ V). The user can provide an external bias to this pad (1.5 to 1.2 volts less than V_{CC}) to force the pre-scaler to operate at a system generated logic threshold voltage.

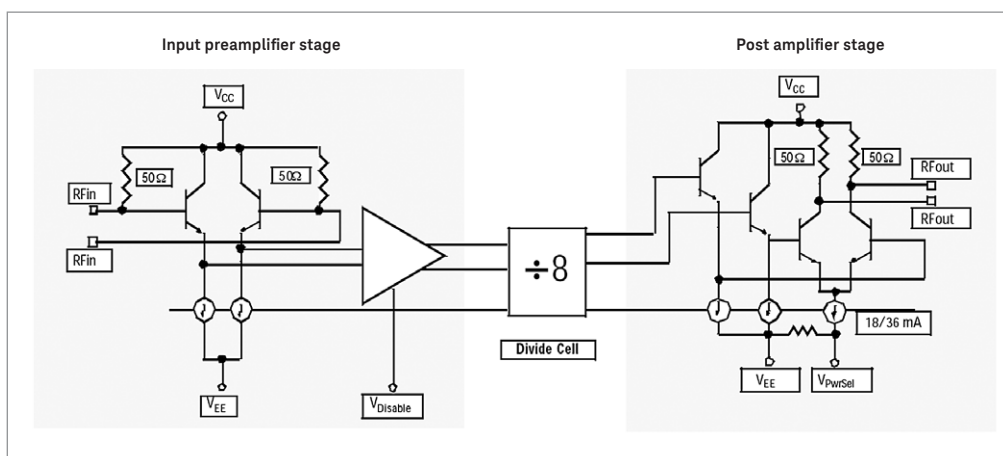

Figure 1. Simplified schematic diagram

3. Input disable feature

If an RF signal with sufficient signal-to-noise ratio is present at the RF input, the prescaler will operate and provide a divided output equal to the input frequency divided by the divide modulus. Under certain “ideal” conditions where the input is well matched at the right input frequency, the device may “self-oscillate,” especially under small signal input powers or with only noise present at the input. This “self-oscillation” will produce an undesired output signal also known as a false trigger. By applying an external bias to the input disable contact pad (more positive than $V_{CC} - 1.35\text{ V}$), the input preamplifier stage is locked into either logic “high” or logic “low” preventing frequency division and any self-oscillation frequency which may be present.

4. Input dc offset

Another method used to prevent false triggers or self-oscillation conditions is to apply a 20 to 100 mV dc offset voltage between the RF_{in} and \overline{RF}_{in} ports. This prevents noise or spurious low level signals from triggering the divider.

Adding a 10 k Ω resistor between the unused RF input to a contact point at the V_{EE} potential will result in an offset of $\sim 25\text{ mV}$ between the RF inputs. Note however, that the input sensitivity will be reduced slightly due to the presence of this offset.

Assembly Techniques

Figure 3 shows the chip assembly diagram for single-ended I/O operation through 12 GHz for either positive or negative bias supply operation. In either case the supply contact to the chip must be capacitively bypassed to provide good input sensitivity and low input power feedthrough. Independent of the bias applied to the device, the backside of the chip should always be connected to both a good RF ground plane and a good thermal heat sinking region on the mounting surface.

All RF ports are dc connected on-chip to the V_{CC} contact through on-chip 50 Ω resistors. Under any bias conditions where V_{CC} is not dc grounded, the RF ports should be ac coupled via series capacitors mounted on the thin-film substrate at each RF port. Only under bias conditions where V_{CC} is dc grounded (as is typical for negative bias supply operation) may the RF ports be direct coupled to adjacent circuitry or in some cases, such as level shifting to subsequent stages. In the latter case the device backside may be “floated” and bias applied as the difference between V_{CC} and V_{EE} .

All bonds between the device and this bypass capacitor should be as short as possible to limit the inductance. For operation at frequencies below 1 GHz, a large value capacitor must be added to provide proper RF bypassing.

Due to on-chip 50 Ω matching resistors at all four RF ports, no external termination is required on any unused RF port. However, improved “Spitback” performance ($\sim 20\text{ dB}$) and input sensitivity can be achieved by terminating the unused RF_{out} port to V_{CC} through 50 Ω (positive supply) or to ground via a 50 Ω termination (negative supply operation).

GaAs MMICs are ESD sensitive. ESD preventive measures must be employed in all aspects of storage, handling, and assembly.

MMIC ESD precautions, handling considerations, die attach and bonding methods are critical factors in successful GaAs MMIC performance and reliability.

Keysight Technologies publication, *GaAs MMIC ESD, Die Attach and Bonding Guidelines* – Application Note (5991-3484EN) provides basic information on these subjects.

Optional dc Operating Values/Logic Levels

($T_A = 25\text{ }^\circ\text{C}$)

Function	Symbol	Conditions	Min (volts/mA)	Typ (volts/mA)	Max (volts/mA)
Logic Threshold ¹	V_{Logic}		$V_{CC}-1.5$	$V_{CC}-1.35$	$V_{CC}-1.2$
Input Disable	$V_{Disable(High)}$ [Disable]		$V_{Logic} + 0.25$	V_{Logic}	V_{CC}
Input Disable	$V_{Disable(Low)}$ [Enable]		V_{EE}	V_{Logic}	$V_{Logic} - 0.25$
Input Disable	$I_{Disable}$	$V_D > V_{EE}+3$	$V_{Disable} - V_{EE} - 3)/500$	$V_{Disable} - V_{EE} - 3)/500$	$V_{Disable} - V_{EE} - 3)/500$
Input Disable	$I_{Disable}$	$V_D < V_{EE}+3$	0	0	0

1. Acceptable voltage range when applied from external source.

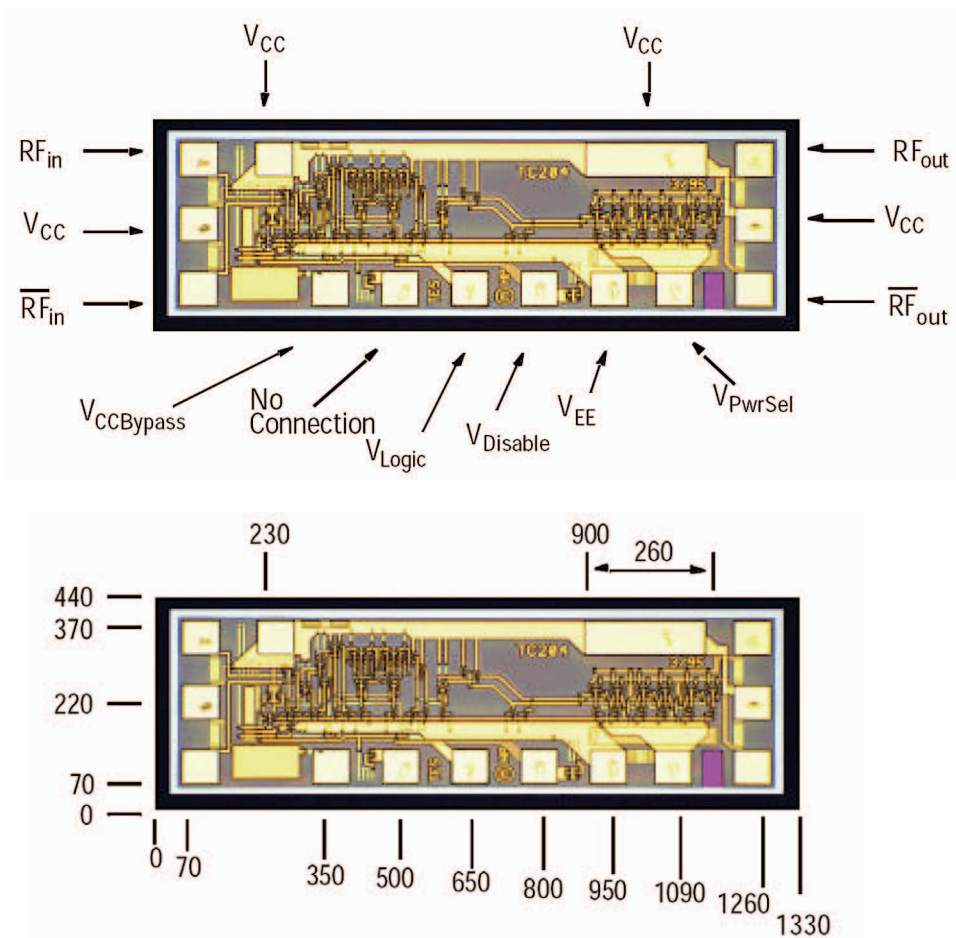

Notes:

1. All dimensions in micrometers.
2. All pad dim: $70 \times 70\text{ }\mu\text{m}$ (except where noted).
3. Tolerances: $\pm 10\text{ }\mu\text{m}$
4. Chip thickness: $127 \pm 15\text{ }\mu\text{m}$

Figure 2. Pad locations and chip dimensions

POSITIVE SUPPLY

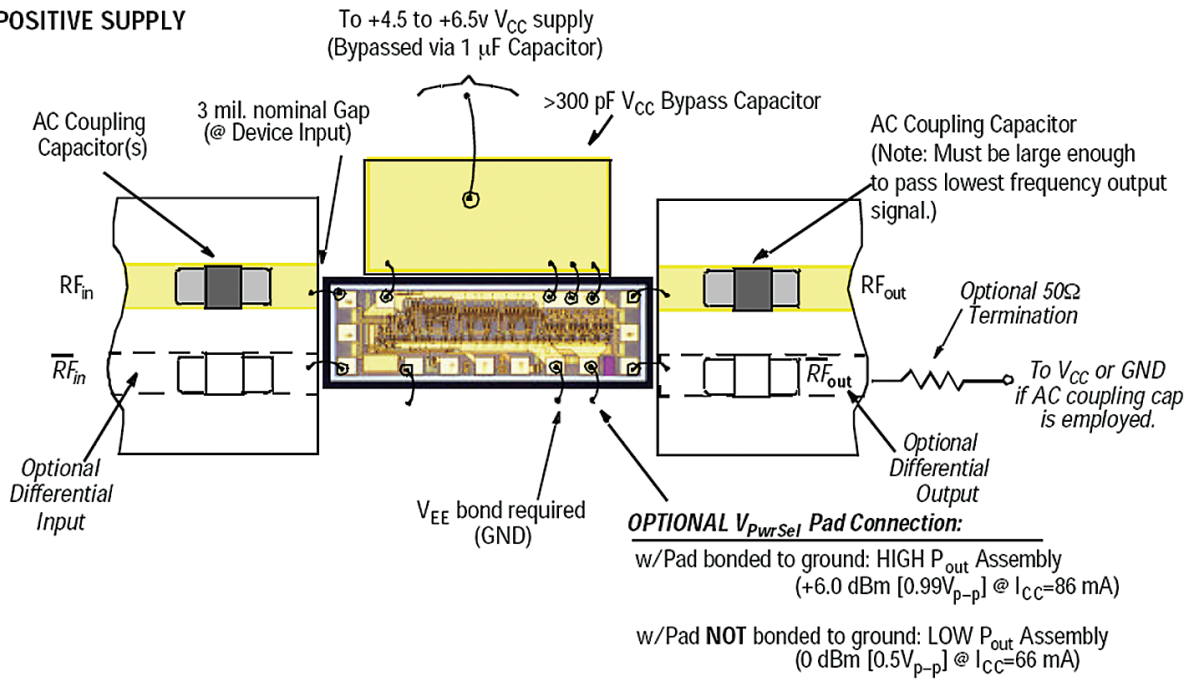

NEGATIVE SUPPLY

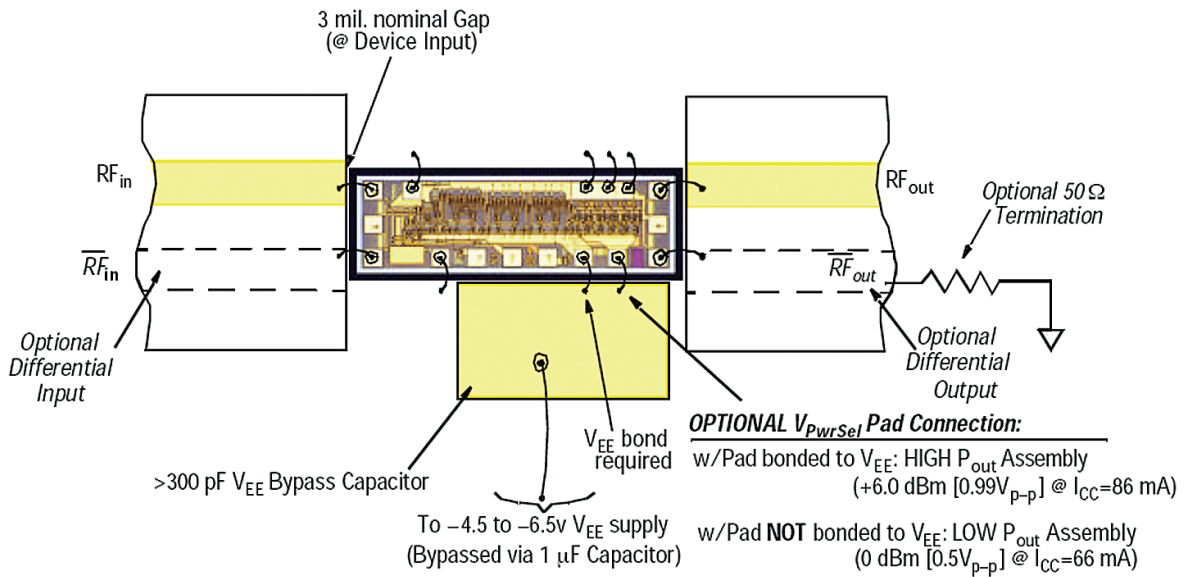

Figure 3. Assembly diagrams

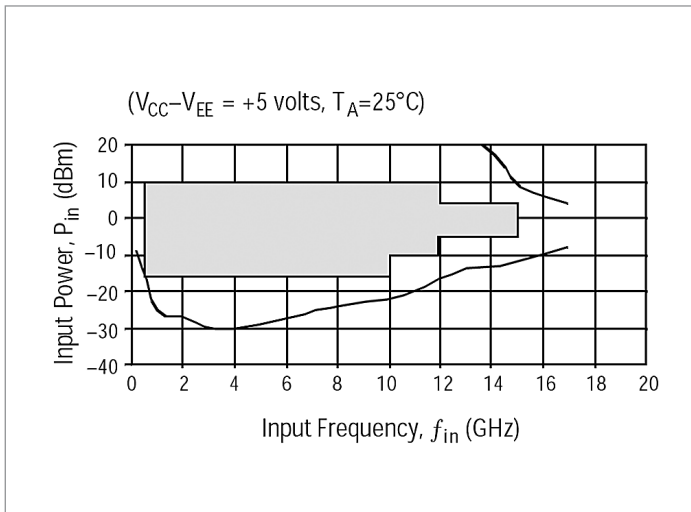

Figure 4. Typical input sensitivity window

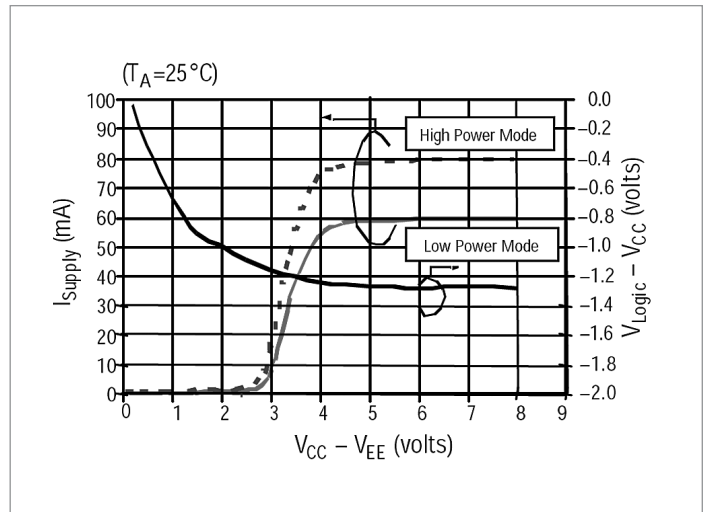

Figure 5. Typical supply current & V_{Logic} vs. supply voltage

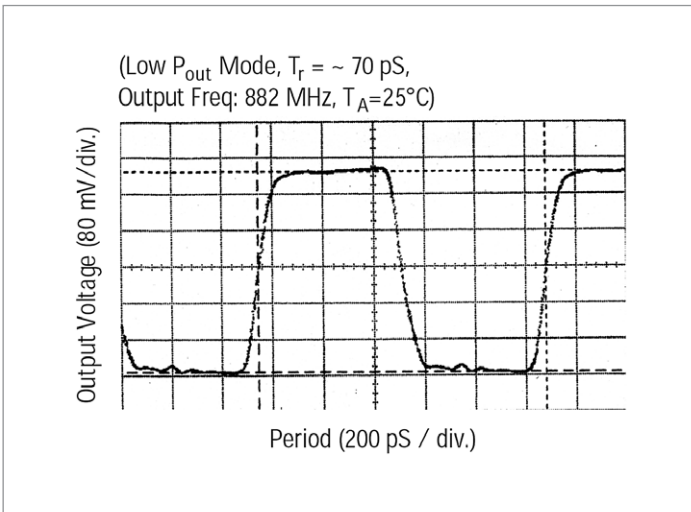

Figure 6. Typical output voltage waveform

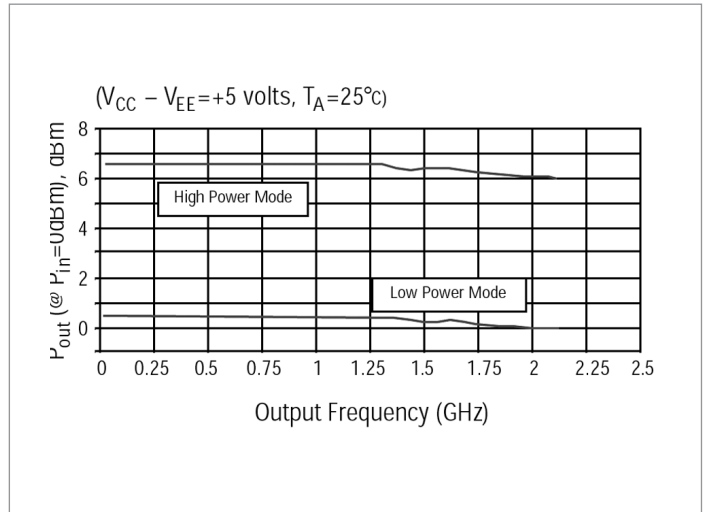

Figure 7. Typical output power vs. output frequency, f_{out} (GHz)

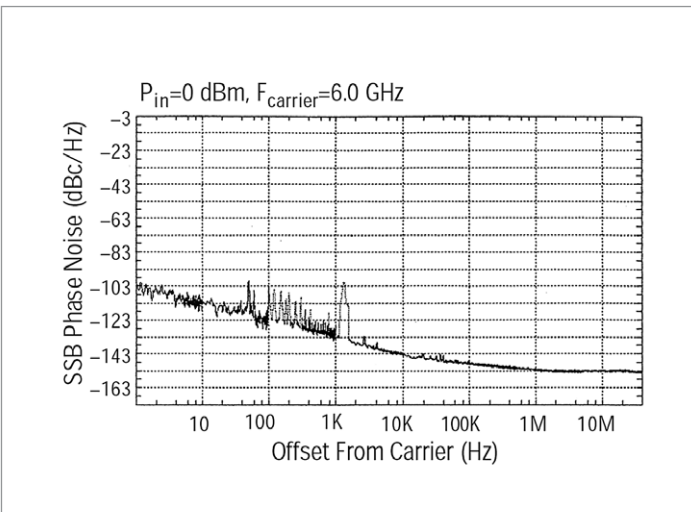

Figure 8. Typical phase noise performance

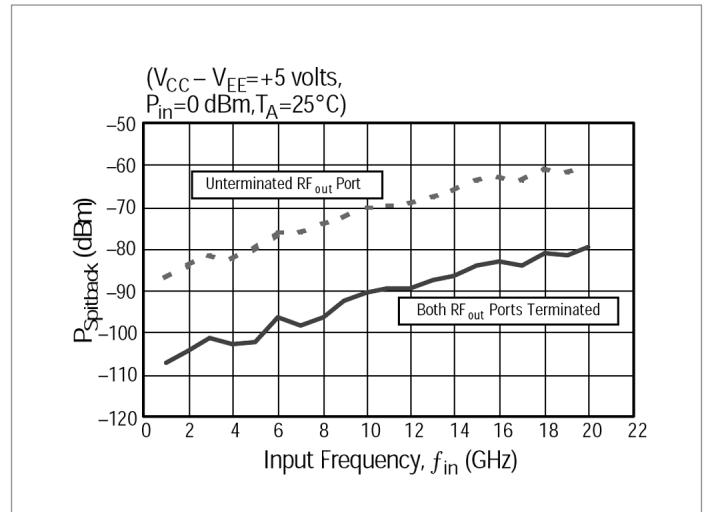

Figure 9. Typical "spitback" power $P(f_{out})$ appearing at RF input port

myKeysight

myKeysight

www.keysight.com/find/mykeysight

A personalized view into the information most relevant to you.

Three-Year Warranty

www.keysight.com/find/ThreeYearWarranty

Keysight's commitment to superior product quality and lower total cost of ownership. The only test and measurement company with three-year warranty standard on all instruments, worldwide.



Keysight Assurance Plans

www.keysight.com/find/AssurancePlans

Up to five years of protection and no budgetary surprises to ensure your instruments are operating to specification so you can rely on accurate measurements.



www.keysight.com/quality

Keysight Technologies, Inc.

DEKRA Certified ISO 9001:2008

Quality Management System



Keysight Channel Partners

www.keysight.com/find/channelpartners

Get the best of both worlds: Keysight's measurement expertise and product breadth, combined with channel partner convenience.

www.keysight.com/find/mmic

This data sheet contains a variety of typical and guaranteed performance data. The information supplied should not be interpreted as a complete list of circuit specifications. Customers considering the use of this, or other Keysight Technologies GaAs ICs, for their design should obtain the current production specifications from Keysight Technologies. In this data sheet the term typical refers to the 50th percentile performance. For additional information contact Keysight Technologies at MMIC_Helpline@keysight.com.

For more information on Keysight Technologies' products, applications or services, please contact your local Keysight office. The complete list is available at: www.keysight.com/find/contactus

Americas

Canada	(877) 894 4414
Brazil	55 11 3351 7010
Mexico	001 800 254 2440
United States	(800) 829 4444

Asia Pacific

Australia	1 800 629 485
China	800 810 0189
Hong Kong	800 938 693
India	1 800 112 929
Japan	0120 (421) 345
Korea	080 769 0800
Malaysia	1 800 888 848
Singapore	1 800 375 8100
Taiwan	0800 047 866
Other AP Countries	(65) 6375 8100

Europe & Middle East

Austria	0800 001122
Belgium	0800 58580
Finland	0800 523252
France	0805 980333
Germany	0800 6270999
Ireland	1800 832700
Israel	1 809 343051
Italy	800 599100
Luxembourg	+32 800 58580
Netherlands	0800 0233200
Russia	8800 5009286
Spain	0800 000154
Sweden	0200 882255
Switzerland	0800 805353
	Opt. 1 (DE)
	Opt. 2 (FR)
	Opt. 3 (IT)
United Kingdom	0800 0260637

For other unlisted countries:
www.keysight.com/find/contactus
 (BP-07-10-14)